

Schottky Rectifier, 175 A

PowerTab™

FEATURES

- 150 °C T_J operation
- High frequency operation
- Ultralow forward voltage drop
- Continuous high current operation
- Guard ring for enhanced ruggedness and long term reliability
- PowerTab™ package
- Lead (Pb)-free plating
- Compliant to RoHS directive 2002/95/EC

RoHS
COMPLIANT

PRODUCT SUMMARY

$I_{F(AV)}$	175 A
V_F at 175 A at 25 °C	0.75 V
I_R at 125 °C	640 mA
V_R	45 V

DESCRIPTION

The 175BGQ045 Schottky rectifier has been optimized for ultralow forward voltage drop specifically for low voltage output in high current AC/DC power supplies.

The proprietary barrier technology allows for reliable operation up to 150 °C junction temperature. Typical applications are in switching power supplies, converters, reverse battery protection, and redundant power subsystems.

MAJOR RATINGS AND CHARACTERISTICS

SYMBOL	CHARACTERISTICS	VALUES	UNITS
$I_{F(AV)}$	Rectangular waveform	175	A
	T_C	103	°C
V_{RRM}		45	V
I_{FSM}	$t_p = 5 \mu s$ sine	8700	A
V_F	175 Apk (typical)	0.63	V
	T_J	150	°C
T_J	Range	- 55 to 150	°C

VOLTAGE RATINGS

PARAMETER	SYMBOL	175BGQ045	UNITS
Maximum DC reverse voltage	V_R	45	V
Maximum working peak reverse voltage	V_{RWM}		

ABSOLUTE MAXIMUM RATINGS

PARAMETER	SYMBOL	TEST CONDITIONS	VALUES	UNITS
Maximum average forward current	$I_{F(AV)}$	50 % duty cycle at $T_C = 103 \text{ °C}$, rectangular waveform	175	A
Maximum peak one cycle non-repetitive surge current	I_{FSM}	5 μs sine or 3 μs rect. pulse	8700	A
		10 ms sine or 6 ms rect. pulse		
Non-repetitive avalanche energy	E_{AS}	$T_J = 25 \text{ °C}$, $I_{AS} = 6 \text{ A}$, $L = 2 \text{ mH}$	40	mJ
Repetitive avalanche current	I_{AR}	Current decaying linearly to zero in 1 μs Frequency limited by T_J maximum $V_A = 1.5 \times V_R$ typical	6	A

ELECTRICAL SPECIFICATIONS						
PARAMETER	SYMBOL	TEST CONDITIONS		TYP.	MAX.	UNITS
Forward voltage drop	$V_{FM}^{(1)}$	100 A	$T_J = 25\text{ }^\circ\text{C}$	0.55	0.58	V
		175 A		0.67	0.75	
		100 A	$T_J = 150\text{ }^\circ\text{C}$	0.49	0.54	
		175 A		0.63	0.7	
Reverse leakage current	$I_{RM}^{(1)}$	$T_J = 150\text{ }^\circ\text{C}, V_R = 45\text{ V}$		1200	2000	mA
		$T_J = 25\text{ }^\circ\text{C}$	$V_R = \text{Rated } V_R$	0.6	2	
		$T_J = 125\text{ }^\circ\text{C}$		360	640	
Maximum junction capacitance	C_T	$V_R = 5\text{ V}_{DC}$, (test signal range 100 kHz to 1 MHz) $25\text{ }^\circ\text{C}$		5600		pF
Typical series inductance	L_S	Measured from tab to mounting plane		3.5		nH
Maximum voltage rate of change	dV/dt	Rated V_R		10 000		V/ μ s

Note(1) Pulse width < 300 μ s, duty cycle < 2 %

THERMAL - MECHANICAL SPECIFICATIONS				
PARAMETER	SYMBOL	TEST CONDITIONS	VALUES	UNITS
Maximum junction and storage temperature range	T_J, T_{Stg}		- 55 to 150	$^\circ\text{C}$
Maximum thermal resistance, junction to case	R_{thJC}	DC operation	0.25	$^\circ\text{C/W}$
Typical thermal resistance, case to heatsink	R_{thCS}	Mounting surface, smooth and greased	0.20	
Approximate weight			5	g
			0.18	oz.
Mounting torque	minimum		1.2 (10)	N · m (lbf · in)
	maximum		2.4 (20)	
Marking device		Case style PowerTab™	175BGQ045	

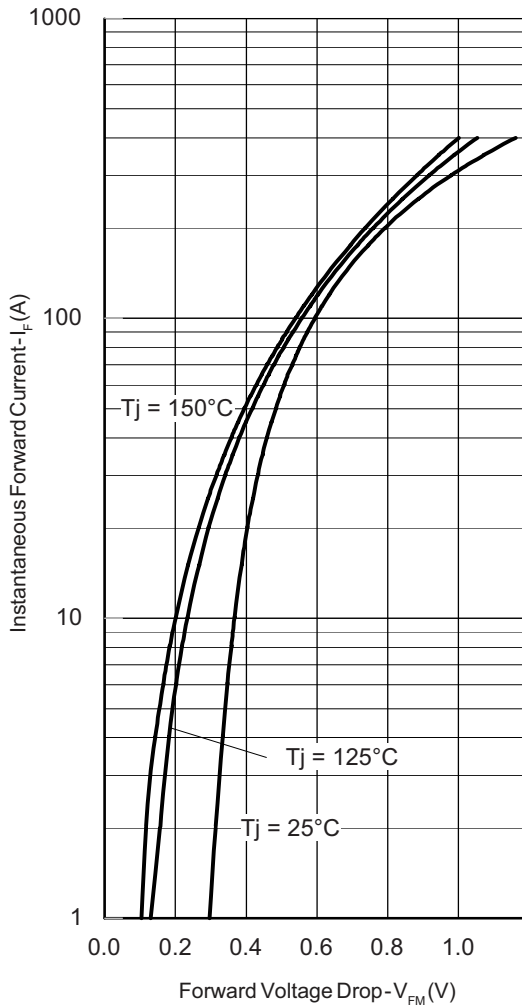

Fig. 1 - Maximum Forward Voltage Drop Characteristics

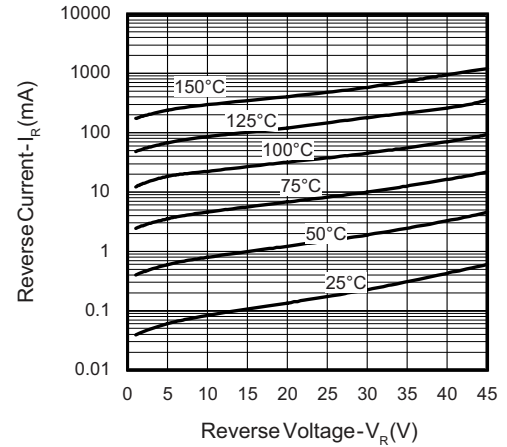

Fig. 2 - Typical Values of Reverse Current vs. Reverse Voltage

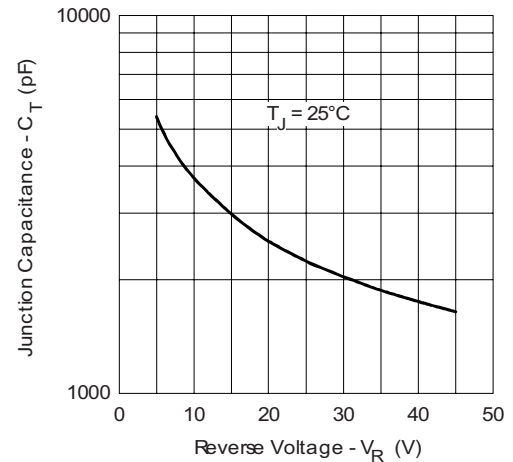

Fig. 3 - Typical Junction Capacitance vs. Reverse Voltage

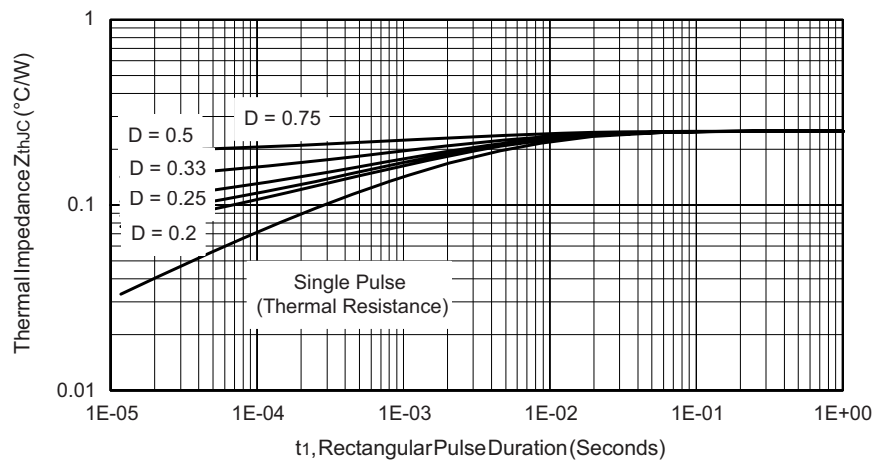

Fig. 4 - Maximum Thermal Impedance Z_{thJC} Characteristics

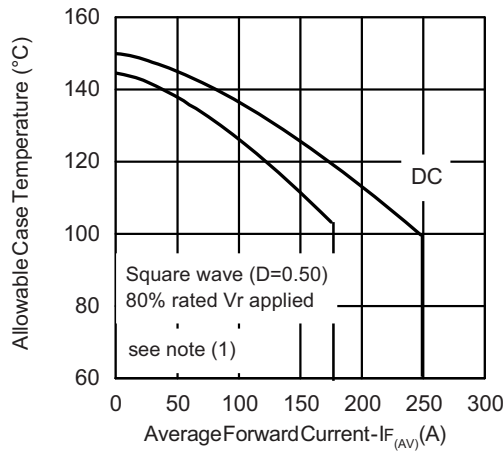

Fig. 5 - Maximum Allowable Case Temperature vs. Average Forward Current

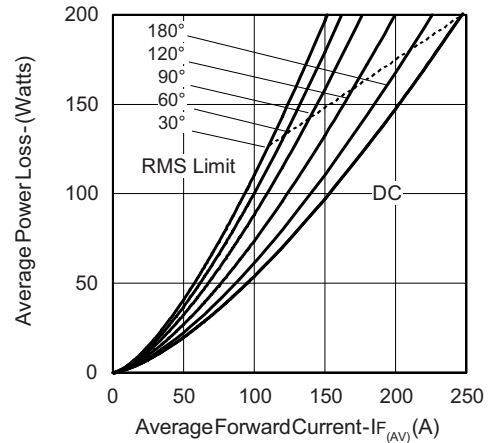

Fig. 6 - Forward Power Loss Characteristics

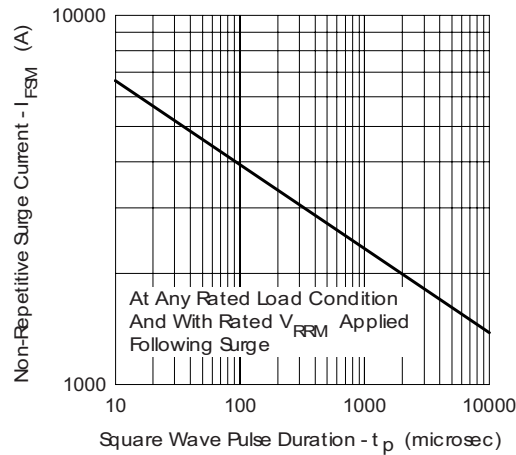

Fig. 7 - Maximum Non-Repetitive Surge Current

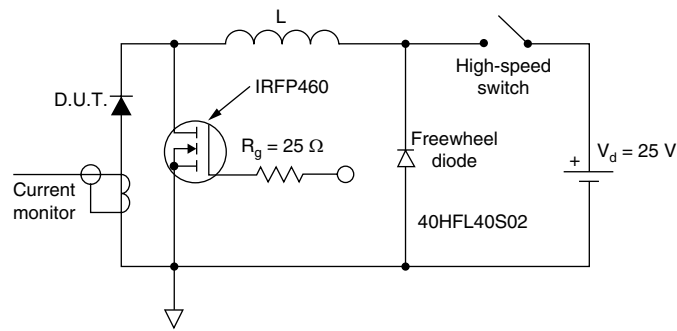

Fig. 8 - Unclamped Inductive Test Circuit

Note

- (1) Formula used: $T_C = T_J - (P_d + P_{d_{REV}}) \times R_{thJC}$;
- P_d = Forward power loss = $I_{F(AV)} \times V_{FM}$ at $(I_{F(AV)}/D)$ (see fig. 6);
- $P_{d_{REV}}$ = Inverse power loss = $V_{R1} \times I_R (1 - D)$; I_R at $V_{R1} = 80\%$ rated V_R



ORDERING INFORMATION TABLE

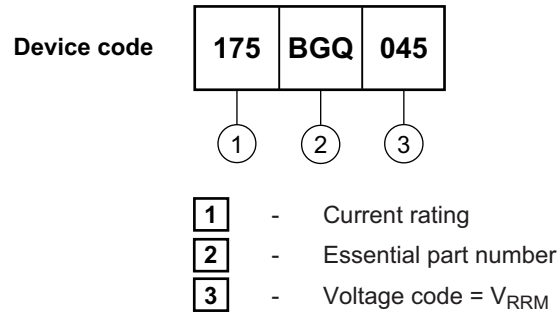

LINKS TO RELATED DOCUMENTS	
Dimensions	www.vishay.com/doc?95240
Part marking information	www.vishay.com/doc?95370
Application note	www.vishay.com/doc?95179



Disclaimer

All product specifications and data are subject to change without notice.

Vishay Intertechnology, Inc., its affiliates, agents, and employees, and all persons acting on its or their behalf (collectively, "Vishay"), disclaim any and all liability for any errors, inaccuracies or incompleteness contained herein or in any other disclosure relating to any product.

Vishay disclaims any and all liability arising out of the use or application of any product described herein or of any information provided herein to the maximum extent permitted by law. The product specifications do not expand or otherwise modify Vishay's terms and conditions of purchase, including but not limited to the warranty expressed therein, which apply to these products.

No license, express or implied, by estoppel or otherwise, to any intellectual property rights is granted by this document or by any conduct of Vishay.

The products shown herein are not designed for use in medical, life-saving, or life-sustaining applications unless otherwise expressly indicated. Customers using or selling Vishay products not expressly indicated for use in such applications do so entirely at their own risk and agree to fully indemnify Vishay for any damages arising or resulting from such use or sale. Please contact authorized Vishay personnel to obtain written terms and conditions regarding products designed for such applications.

Product names and markings noted herein may be trademarks of their respective owners.